

Operation manual

Action Shower „Water Fun“

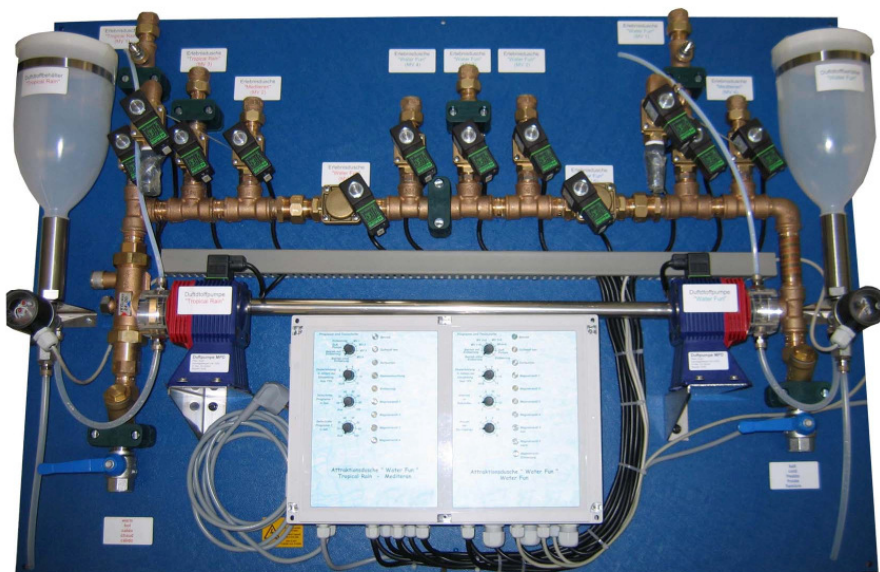

Table of contents	page
1. Instructions for the manual.....	3
1.1 Validity.....	3
1.2 Target group.....	3
1.3 Storage of the manual.....	3
1.4 Further information.....	3
1.5 Used symbols.....	3
2. Safety.....	4
2.1 Technical safety advices.....	4
2.3 Use in accordance with regulations.....	5
3. Delivery.....	5
4. Short description.....	5
5. Technical description.....	5
5.1 Measures / Weight.....	6
6. Function.....	6
6.1 Programme / Programme flow.....	6
7. The controller.....	7
7.1 Settings of the program for “Water Fun”.....	7
7.2 Settings of the program for “Tropical Rain - Mediteran”.....	9
7.4 Settings sound volume (MP3-Player) :.....	11
8. Technical Description.....	12
9. Installation.....	13
9.1 Temperature adjustement.....	15
9.2 Place of installation.....	16
9.3 Electrical connection.....	16
9.4 Water connection.....	16
9.5 Push-button.....	16
10. Taking into operation.....	19
11. Taking the unit out of operation.....	19
12. Maintenance.....	19
13. Wiring diagramme.....	21
14. Contact.....	21

1. Instructions for the manual

1.1 Validity

This manual describes the installation, taking into operation and operation of the unit.

1.2 Target group

Only instructed people are allowed to operate the unit. Connection works can only be done by qualified craftsmen.



1.3 Storage of the manual

The manual has to be stored in the direct surrounding of the installed unit. It has always to be accessible.

1.4 Further information

For further information please contact [WDT](#).







1.5 Used symbols

	<p>Attention! Warning of danger!</p> <p>Failure to observe this warning may result in serious injury or death and/or damage to the unit</p> <p>Every explanation of this sign has to be considered!</p>
	<p>Attention! Warning of hazardous electrical voltage!</p> <p>Danger, Hazardous Voltage: Hazardous electrical current! Failure to observe this warning may result in injury or even serious injury or death.</p> <p>Every explanation of this sign has to be considered!</p>
	<p>Advise!</p> <p>This sign refers to circumstances that can affect the functioning of the unit in a positive as well as in a negative way.</p>

2. Safety

2.1 Technical safety advices

WDT does not take the liability for damages that occur due to not considering this manual. The easy and safe operation of the unit assumes a correct transport, storage and installation of the unit. Respect the following advices to minimize the risk in injury or even serious injury or death.

	<p>The installation of the unit has to be done in accordance with the safety norms (e.g. DIN/ VDE) and all other relevant governmental norms and laws.</p> <p>During the operation all covers of the unit have to be closed.</p> <p>Disconnect unit components from power supply prior to maintenance or repair work.</p>
 	<p>General</p> <p>Obey all safety notes and warnings present on the unit. In case of a malfunction, switch off the unit immediately and prevent a restart. Repair malfunctions promptly. After any repair work, have qualified personnel check the safe operation of the unit. Use original spare parts only. Additional national safety regulations also fully apply to the operation of this unit.</p>
	<p>Accident Prevention Regulations</p> <p>Comply with the accident prevention regulation Accident Prevention Regulation Electrical Systems and Equipment (VBG4/BGVA2) to prevent injury to yourself and others.</p>
	<p>Operation of the Unit</p> <p>Do not perform any work which compromises the safety of the unit. Regularly check that all safety and monitoring devices are functioning normally. Do not remove or disable safety devices.</p>
	<p>Installation, Dismantling, Maintenance and Repair of the Unit</p> <p>Disconnect unit components from power supply prior to maintenance or repair work. Attaching or installing additional components is permitted only with the consent of the manufacturer.</p> <p>Work on the electrical system must be performed by qualified personnel. Disconnect unit components from power supply prior to work. In case of a malfunction in the electrical power supply, switch off the unit immediately. Use only original fuses with the appropriate amperage rating.</p>

2.3 Use in accordance with regulations

The unit is only designed for the operation in the described use. Other fields of use are not allowed.

3. Delivery

- Please look after transport damage when the unit arrived.
- Do not let the goods fall down, do not throw the goods!
- Open package carefully!



Note: The operator is responsible for the disposal of unit components as required by law.

4. Short description

Experience Showers are activating all senses of the user. Aromatized rain showers with light and sound effects are creating unique dream worlds.

5. Technical description

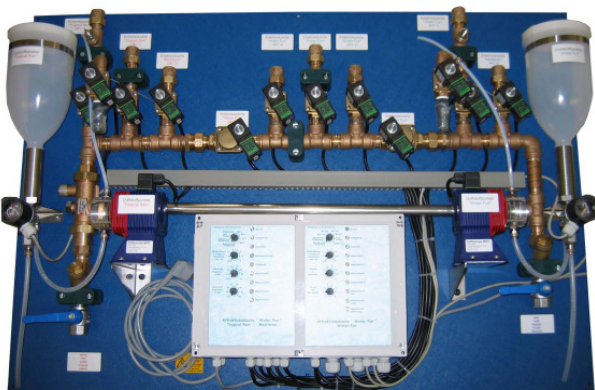

Shower



Function plate

5.1 Measures / Weight

Measures: W 120cm, H 75cm, D 35cm
 Weight: app. 25-30 kg

6. Function

The Experience Shower „**Water Fun**“ is a control unit for several shower programmes. The programmes can be started by a 3-fold push-button from the shower cabinet.

6.1 Programme / Programme flow

Standby: illumination white

Program 1: "Water Fun"

- Step 1: cold Fog with fragrance
 Sound see
 Illumination blue
- Step 2: cold Side nozzles down
 Sound see
 Illumination blue
- Step 3: cold Side nozzles middle
 Sound see
 Illumination blue
- Step 4: cold Side nozzles top
 Sound see
 Illumination blue
- Step 5: warm Side nozzles top
 Sound water
 Illumination red
- Step 6: warm Side nozzles middle
 Sound Water
 Illumination red
- Step 7: warm Side nozzles down
 Sound Water
 Illumination red
- Step 8: cold Fog with fragrance
 Sound Water
 Illumination red

Program 2: "Tropical Rain"

- Step 1: warm Drizzle Rain with fragrance
 Sound birds
 Illumination colour change red-green
- Step 2: warm Drizzle Rain
 + warm Tropical Rain
 Sound birds
 Illumination colour change red-green

Step 3: warm Drizzle Rain with fragrance
 Sound birds
 Illumination colour change red-green

Program 3: "Mediteran"

Step 1: cold Fog
 Sound thunder storm
 Illumination colour change red-green-blue

Step 2: cold Fog
 + warm Drizzle Rain
 Sound thunder storm
 Illumination colour change red-green-blue

Step 3: warm Drizzle Rain
 Sound thunder storm
 Illumination colour change red-green-blue

7. The controller

7.1 Settings of the program for "Water Fun":

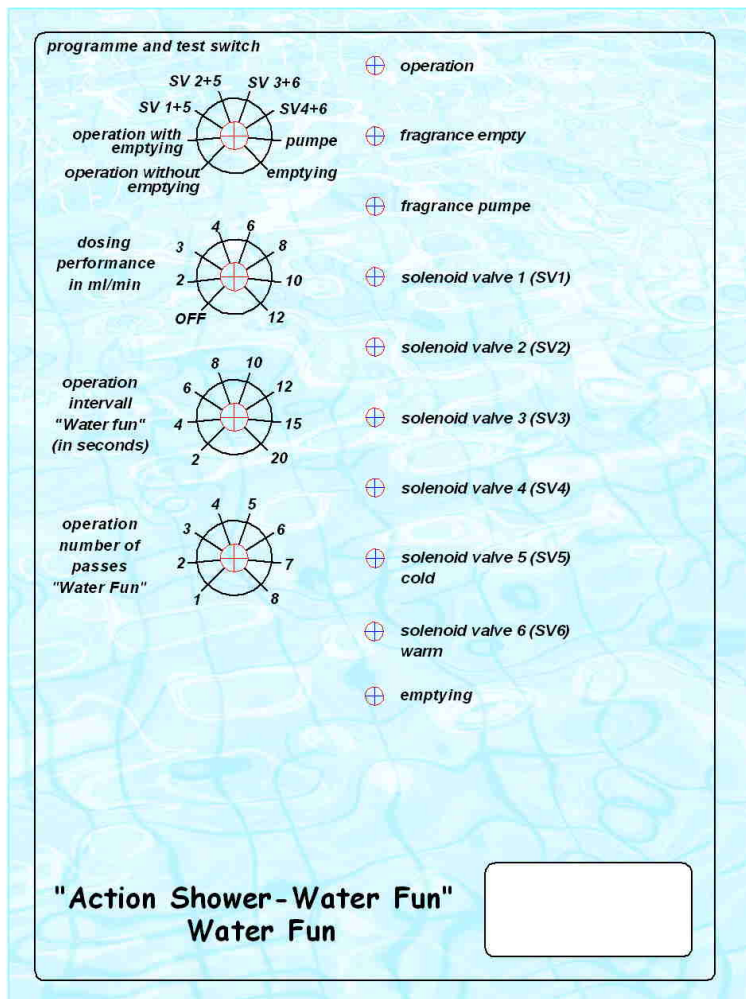

The single adjustments are handled by rotary knobs at the control housing:

Programme and test switch

This rotary knob is to test every function of the action shower and to set the operation mode.

Operation without emptying:

The emptying is an option to drain aromatized tubes after every programme. This function is to prevent that a aroma-water mixture will rest in the tubing for too long. If no emptying valve or drainage will be installed this operation mode has to be chosen.

Operation with emptying: This mode has to be adjusted at all shower techniques that include emptying valves.

Before the operation mode will be chosen every function of the shower has to be tested. Each function is indicated by a burning of the yellow LED on the right side of the control housing. The fragrance pump can only be operated if the fragrance canister is filled or if the pressure switch below the pump is bridged.

Test SV 1+5 (solenoid valves/side nozzles) At this position solenoid valve open. This function is additionally indicated by a shining of the LED at the plug of the valve. The test function switches off automatically after 60 seconds.

Test SV 2+5 (solenoid valves/side nozzles) At this position solenoid valve open. This function is additionally indicated by a shining of the LED at the plug of the valve. The test function switches off automatically after 60 seconds.

Test SV 3+6 (solenoid valves/side nozzles) At this position solenoid valve open. This function is additionally indicated by a shining of the LED at the plug of the valve. The test function switches off automatically after 60 seconds.

Test SV 4+6 (solenoid valves/side nozzles) At this position solenoid valve open. This function is additionally indicated by a shining of the LED at the plug of the valve. The test function switches off automatically after 60 seconds.

Test pump :

At this position the aroma pump starts to work. This function is additionally indicated by a shining of the LED at the plug of the pump. The test function switches off automatically after 60 seconds.

Test emptying: At this position the emptying valve open (if installed). **!!** Please consider to connect this valve to the drain before the test **!!** This function is additionally indicated by a shining of the LED at the plug of the valve. The test function switches off automatically after 60 seconds.

dosing performance in ml/min -pump:

This rotary knob is to adjust the fragrance dosing performance.

operation intervall:

Adjustment of the intervall time for 2-20 seconds.

operation number of passes:

Adjustment of the number of passes 1-8 one.

!!! Please consider: No one of the rotary knoks must be on Position „OFF“ / „AUS“ !!!

7.2 Settings of the program for “Tropical Rain - Mediteran”:

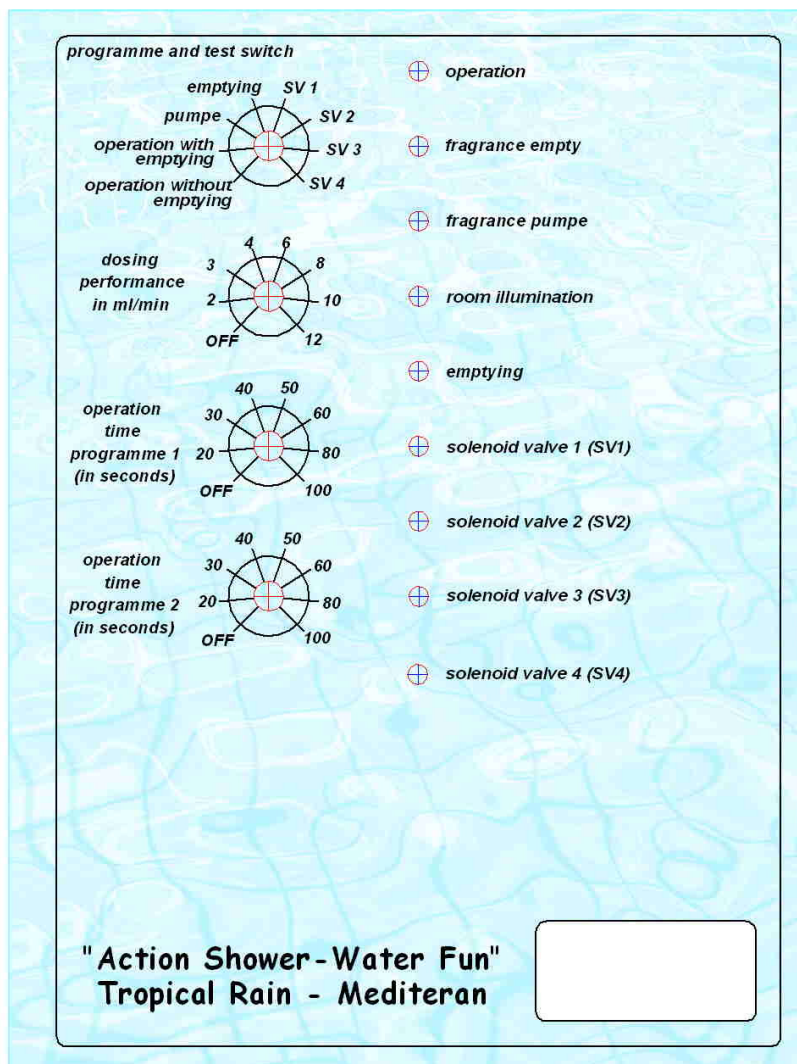

The single adjustments are handled by rotary knobs at the control housing:

Programme and test switch

This rotary knob is to test every function of the action shower and to set the operation mode.

Operation without emptying:

The emptying is an option to drain aromatized tubes after every programme. This function is to prevent that a aroma-water mixture will rest in the tubing for too long. If no emptying valve or drainage will be installed this operation mode has to be chosen.

Operation with emptying: This mode has to be adjusted at all shower techniques that include emptying valves.

Before the operation mode will be chosen every function of the shower has to be tested. Each function is indicated by a burning of the yellow LED on the right side of the control housing. The fragrance pump can only be operated if the fragrance canister is filled or if the pressure switch bellow the pump is bridged.

Test pump :

At this position the aroma pump starts to work. This function is additionally indicated by a shining of the LED at the plug of the pump. The test function switches off automatically after 60 seconds.

Test emptying: At this position the emptying valve opens for 8 seconds (if installed). **!!** Please consider to connect this valve to the drain before the test **!!** This function is additionally indicated by a shining of the LED at the plug of the valve. The test function switches off automatically after 60 seconds.

Test SV 1 (solenoid valves – Tropical Rain): At this position solenoid valve open. This function is additionally indicated by a shining of the LED at the plug of the valve. The test function switches off automatically after 60 seconds.

Test SV 2 (solenoid valves – Tropical Rain): At this position solenoid valve open. This function is additionally indicated by a shining of the LED at the plug of the valve. The test function switches off automatically after 60 seconds.

Test SV 3 (solenoid valves – Drizzle Rain): At this position solenoid valve open. This function is additionally indicated by a shining of the LED at the plug of the valve. The test function switches off automatically after 60 seconds.

Test SV 4 (solenoid valves – Cold Fog): At this position solenoid valve open. This function is additionally indicated by a shining of the LED at the plug of the valve. The test function switches off automatically after 60 seconds.

dosing performance in ml/min -pump:

This rotary knob is to adjust the fragrance dosing performance.

operation time program “Tropical Rain”

Adjustment of the operation time for the cold fog with fragrance from off – 100 seconds.

operation time program “Mediterran”

Adjustment of the operation time for the cold fog with fragrance from off – 100 seconds.

!!! Please consider: No one of the rotary knocs must be on Position „OFF“ / „AUS“ !!!

7.4 Settings sound volume (MP3-Player) :

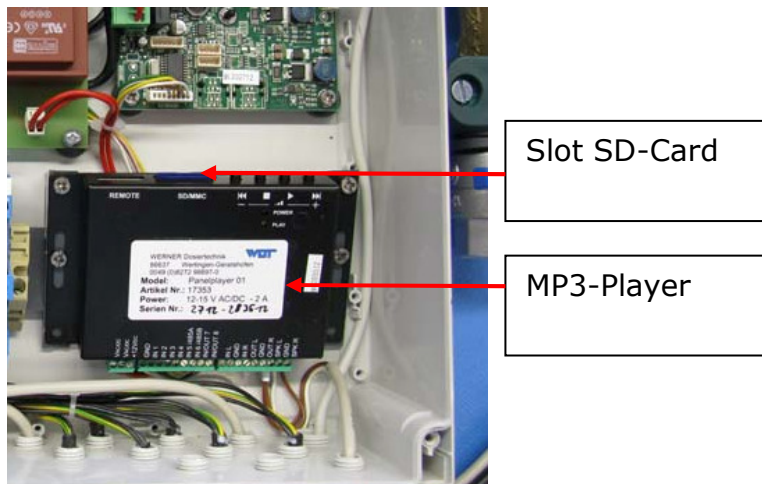

- 1 = Remote control
- 2 = Memory card
- 3 = Operation buttons
- 4 = Voltage indication
- 5 = Function indication
- 6 = Connectors for voltage supply
- 7 = Inputs for choice of the tracks
- 8 = Line input
- 9 = Line output
- 10 = Output for loudspeaker

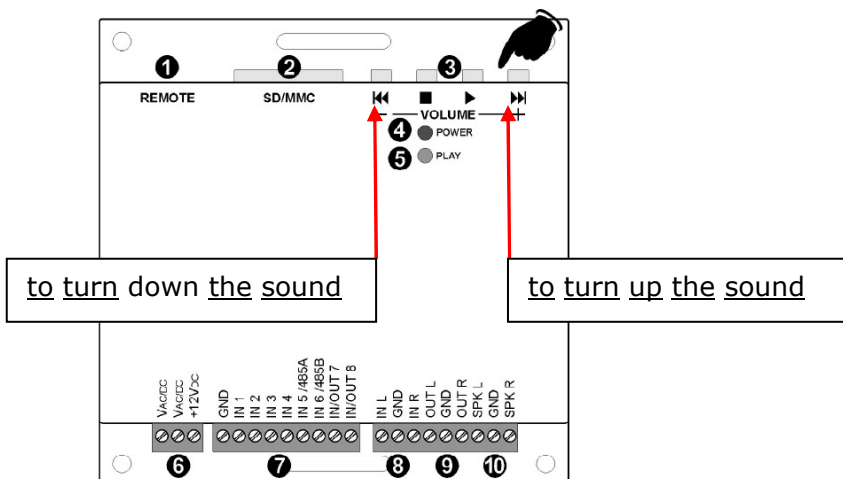

8. Technical Description

The technique consists „Water Fun“ of the following components

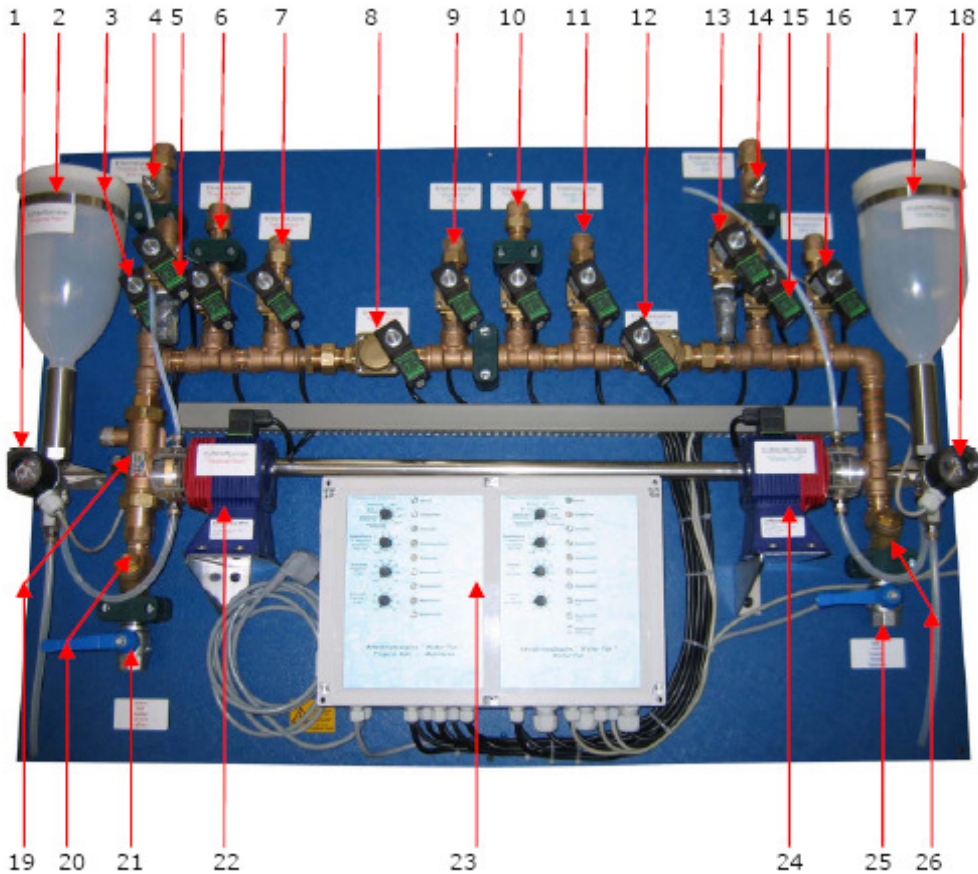

- 1) empty switch Aroma reservoir
- 2) aroma reservoir for fragrance
- 3) solenoid valve 1/2"
- 4) dosing valve for fragrance 3/8"
- 5) solenoid valve 1/2" emptying
- 6) solenoid valve 1/2"
- 7) solenoid valve 1/2"
- 8) solenoid valve 3/4"
- 9) solenoid valve 1/2"
- 10) solenoid valve 1/2"
- 11) solenoid valve 1/2"
- 12) solenoid valve 3/4"
- 13) solenoid valve 1/2" emptying
- 14) dosing valve for fragrance 3/8"
- 15) solenoid valve 1/2"
- 16) solenoid valve 1/2"
- 17) aroma reservoir for fragrance
- 18) empty switch Aroma reservoir
- 19) thermo mixer 3/4" with non return valves 30-45°C (38°C)
- 20) pre filter 3/4" warm water
- 21) supply 3/4" warm water
- 22) aroma Pump

- 23) controller
- 24) aroma Pump
- 25) supply ¾" cold water
- 26) pre filter ¾" cold water

9. Installation

The control unit „ **Water Fun** “ has to be installed at a capable place next to the shower. The water tubing has to be installed according to the following schema. Electrical supply with power plug 230V/AC. Ensure that the nozzles are not blocked by residues that have been in the tubing if you take the unit into operation for the first time!



- **Installation only by authorised staff!!!**
- **Before taking the unit into operation we recommend to flush all the tubings without nozzles to guarantee that no residues will block the nozzles.**
- **We recommend to install a fine in-line strainer before the shower techniques!**
- **We recommend to use (softened) water with a low hardness to prevent residues of calcium!**

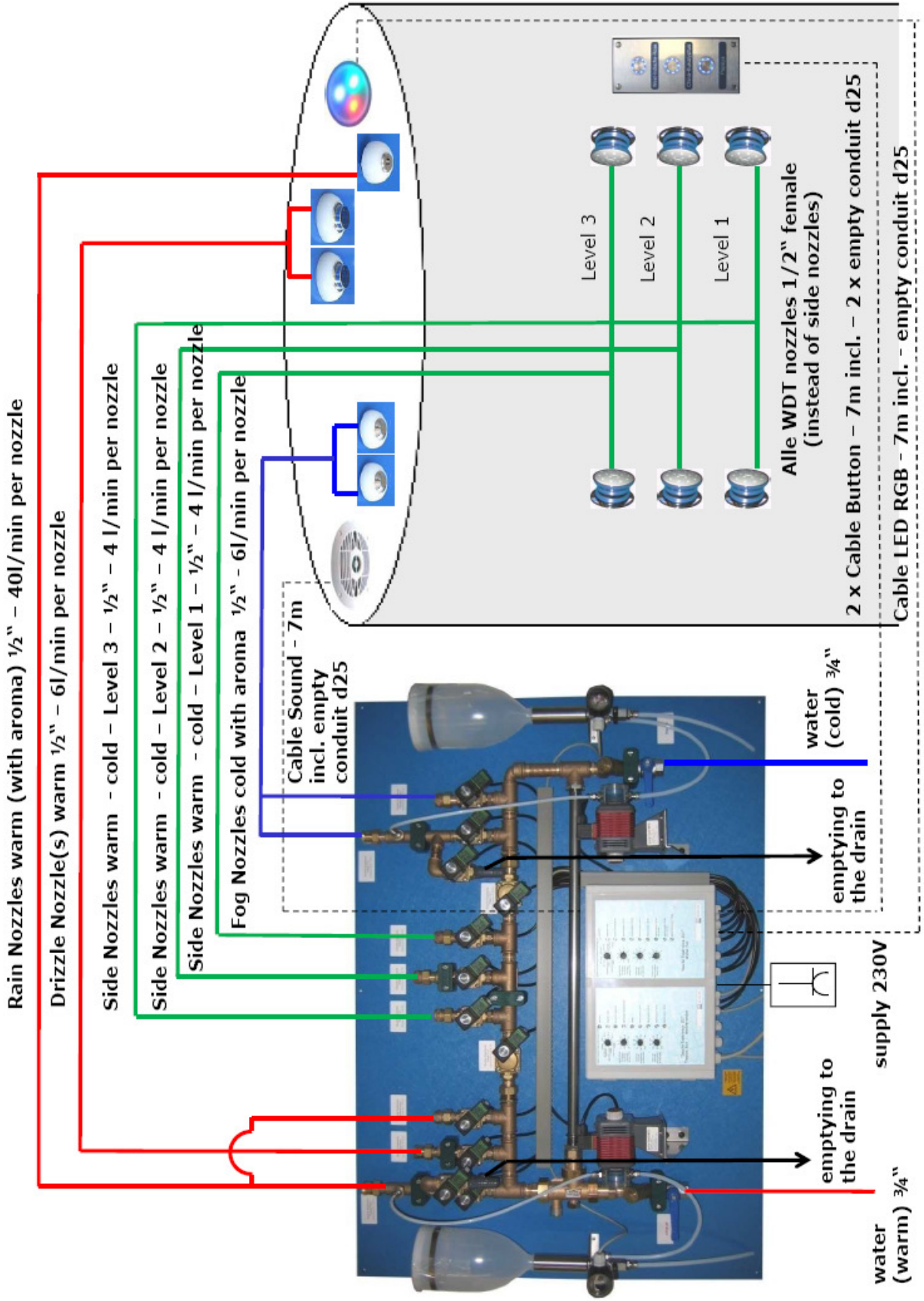

Installation proposal Water Fun - 18987

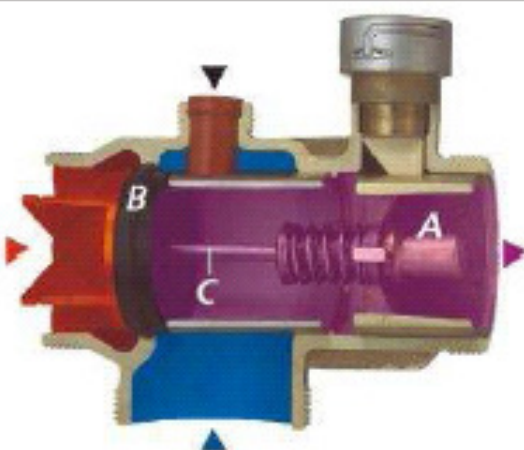

9.1 Temperature adjustment

Cross section

- ▶ Warm
- ▶ Cold
- ▶ Mix / blend
- ▼ Circulation
- A Thermostat
- B Valve slide
- C Pin

1 Standard temperature
2 Limits of the blended water setting range

Function

The blended water temperature is transmitted to the thermostat A. This compares it with the setpoint value. If the blended water temperature does not correspond to the setpoint value, then a volume change takes place in thermostat A. This leads to the valve slide B being regulated by the pin C until the blended water temperature corresponds to the setpoint value.

Classification of the thermal blending valves 3400 in accordance with their noise characteristics:

GN	½	¾ - 1 ¼
DN	15	20 -32
Fittings group	I	II

The warm water temperature has to be at least 5 K higher than the blended water temperature.

Standard temperature set by the factory °C	Limits of the blended water setting ranges °C	Change of the blended water temperature with 1 rotation of the key		
		GN ½ - 1	GN 1¼ -2	DN 65 u. 80
25	20-30	ca.	ca.	ca.
40	30-45			
48	38-53			
55	45-65	6 K	4 K	2 K

9.2 Place of installation

- The unit has to be installed at an easily accessible position for the installation and maintenance.
- The temperature has to be between +5 and +40 °C.
- The relative humidity should be max. 80 %.

9.3 Electrical connection

230V/AC, 50Hz, max. 287W via power socket.

**Attention:**

Electrical works shall only be done by qualified electricians.

9.4 Water connection

The needed water connection has to be according to the no. of the installed nozzles and their consumption.

**Advise! We recommend:**

- Use only water with a total hardness below 6°dH.
- Flush the water tubing before taking the unit into operation.
- We recommend to install an in-line strainer to protect the water supply of the whole SPA center.

- The water part has to be installed as close as possible to the cabinet to avoid long tubings.
- If possible the warm water tubing has to be circulated.
- All water connections have to be done by a qualified plumber.

9.5 Push-button

- We recommend using the WDT bonnet for flush mounting for the installation of the buttons.
- The bonnet has to be mounted according to the enclosed manual.
- The empty-conduit for the button cable has to have an internal diameter of 25mm. The min. bending radius should be 30cm.
- The cable for the button is ready-made and has a plug on both ends. The length of the cable is 7m. On demand the cables can be extended.
- If the push-button plate is installed in humid rooms it has to be sealed against the wall. This has to be done with an elastic sealing kit such as silicon. The executive person is responsible for the sealing.

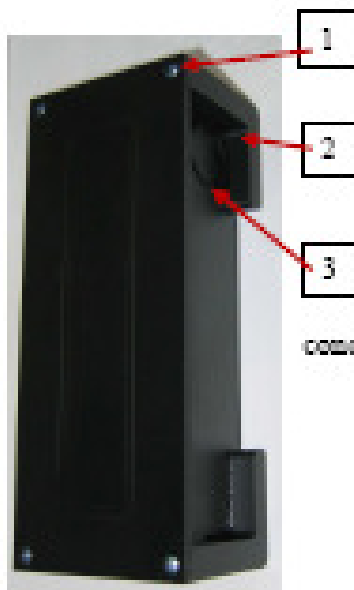
Installation of the bonnets:

Install the top edge of the bonnet (1) flush with the surface of the wall.

The attached angles (2) are to fasten the bonnet in the wall.

A pre-cut opening (3) has to be broken out and a empty conduit (4) 35mm has to be connected. Attention: The radius of the conduit has to be min 30cm.

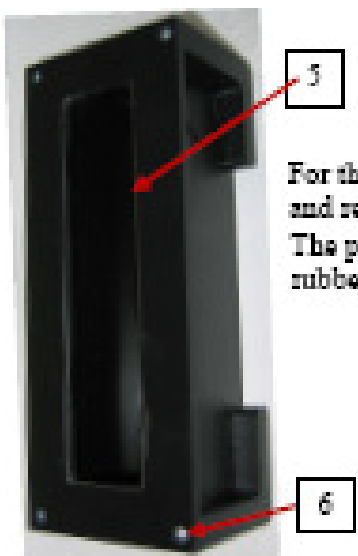
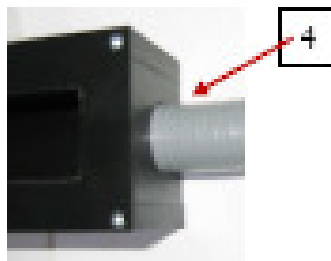

For the installation of the button please break out the pre-cut opening (5) and remove the screws (6). Then install the push-button plate.

The push button plate has to be sealed to the tiles with silicon or a foamed rubber sealing plate.



bonnet for 1 fold push-button plate: D52mm/W65mm/H99mm

bonnet for 2 fold push-button plate: D52mm/W65mm/H142mm

bonnet for 3 fold push-button plate: D52mm/W65mm/H165mm

bonnet for 4 fold push-button plate: D52mm/W65mm/H198mm

10. Taking into operation

Pre-conditions for taking into operation:

- All electrical connections have to be done properly and doublechecked.
- The connections to the steam generator have to be connected.
- The steam generator has to be programmed on external control.
- The water pipes have to be flushed.
- The water connections have to be done properly.
- All connected components have to be installed according to the operation manuals.

If all pre-conditions are fulfilled the units can be supplied with voltage. Switch the controller on by the main switch on the right side of the control housing. While booting the green operation LED blinks. Now the settings at the front plate can be done. Now we recommend testing the components by the test switch. The test functions are time limited. If the tests have been successfully the treatment can be started by the push-button.

11. Taking the unit out of operation

When the unit is taken out of operation the following points have to be considered:

- Close the ball valves of the water supply.
- Empty all water tubings.
- Switch the controller of by the main switch.

12. Maintenance

The technique has to be maintained annually. At a maintenance the following protocol has to be considered:

		⇓ <u>to be done!</u>
1. Water part	⇓	
		⇓
<u>1.1</u>	<u>check solenoid valves in test function</u>	<u>OK [] exchange []</u>
<u>1.2</u>	<u>solenoid valve diaphragms all every two years</u>	<u>OK [] exchange []</u>
<u>1.3</u>	<u>clean pre-filter</u>	<u>OK [] clean []</u>
<u>1.4</u>	<u>filter pressure gauge</u>	<u>OK [] clean []</u>
<u>1.5</u>	<u>check tube cutter</u>	<u>OK</u>
<u>1.6</u>	<u>check function of thermo mixer</u>	<u>OK</u>
2. Fragrance pump		
<u>2.1</u>	<u>function</u>	<u>OK [] exchange []</u>
<u>2.2</u>	<u>valve inserts of the pump every two years</u>	<u>OK [] exchange []</u>
<u>2.3</u>	<u>diaphragms of the pump every two years</u>	<u>OK [] exchange []</u>
<u>2.4</u>	<u>function of the dosing valve 3/8"</u>	<u>OK [] clean []</u>
<u>2.5</u>	<u>check dosing tubes</u>	<u>OK [] exchange []</u>
<u>2.6</u>	<u>function empty switch</u>	<u>OK [] exchange []</u>
3. Nozzles		
<u>3.1</u>	<u>spraying pattern in test function</u>	<u>OK [] clean []</u>
<u>3.2</u>	<u>view of the nozzles</u>	<u>OK [] clean []</u>
4. Controller		
<u>4.1</u>	<u>Test all functions</u>	<u>OK []</u>
<u>4.2</u>	<u>All knobs present?</u>	<u>OK []</u>
4. Miscellaneous		
<u>4.1</u>	<u>Clean the whole unit</u>	<u>[]</u>

13. Wiring diagramme



Work on the electrical system must be performed by qualified personnel. Disconnect unit components from power supply prior to work. In case of a malfunction in the electrical power supply, switch off the unit immediately.
Use only original fuses with the appropriate amperage rating.

You find a wiring diagramme of each controller in the attachment and in the control housing.

14. Contact

WDT

Werner Dosiertechnik GmbH & Co. KG
Hettlinger Str. 17
D-86637 Wertingen – Geratshofen

Tel.: +49 (0)8272/ 98697- 0

Fax: +49 (0)8272/ 98697- 19

E-Mail: info@werner-dosiertechnik.de

Website: <http://www.werner-dosiertechnik.de>